

Features

- Schottky barrier diodes
- Low forward voltage drop
- Low leakage current
- Moisture sensitivity: level 1, per J-STD-020
- Solder dip 260 °C, 10 s
- Low profile - typical height of 1.1 mm
- Heatsink design
- High temperature soldering guaranteed: 260°C/10 seconds
- Halogen-free according to IEC 61249-2-21 definition

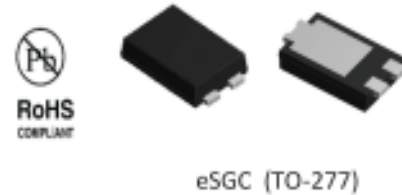

Typical Applications

For low voltage high frequency inverters, DC/DC converters and polarity protection application.

Maximum Ratings (TA = 25 °C unless otherwise noted)			
Parameter	Symbol	SGC101BSA	Unit
Maximum repetitive peak reverse voltage	VRRM	100	V
Maximum RMS voltage	VRMS	70	V
Maximum DC blocking voltage	VDC	100	V
Maximum average forward rectified current	IF(AV) ¹⁾	5.0	A
	IF(AV) ²⁾	10.0	
Peak forward surge current 8.3 ms single half sine-wave superimposed on rated load	IFSM	220	A
Operating junction and storage temperature range	TJ, TSTG	-55 to +150	°C

Electrical Characteristics (TA = 25 °C unless otherwise noted)						
Parameter	Test Conditions		Symbol	TYP.	MAX.	Unit
Instantaneous forward voltage	IF=1A	TA=25°C	VF	0.38	-	Volts
				IF=2A	0.41	
	IF=10A	TA=125°C		0.54	0.65	
				0.50	0.60	
Instantaneous reverse current	VR=80V	TA=25°C	IR	14.9	-	µA
		TA=125°C		9.6	-	mA
	VR=100V	TA=25°C		29.5	500	µA
		TA=125°C		15.2	50	mA
Typical junction capacitance	4.0 V, 1 MHz		CJ	290		pF
Typical thermal resistance	junction to ambient		RθJA ¹⁾	75		°C/W
	junction to mount		RθJM ²⁾	1		°C/W

Notes1)Thermal resistance RθJA is junction to ambient. Free air,mounted on P.C.B with recommended copper pad area,2 OZ_FR4

2)Thermal resistance RθJM is junction to mount.Mounted on P.C.B with 30*30mm copper pad area

Ratings and Characteristics Curves

(TA = 25°C unless otherwise noted)

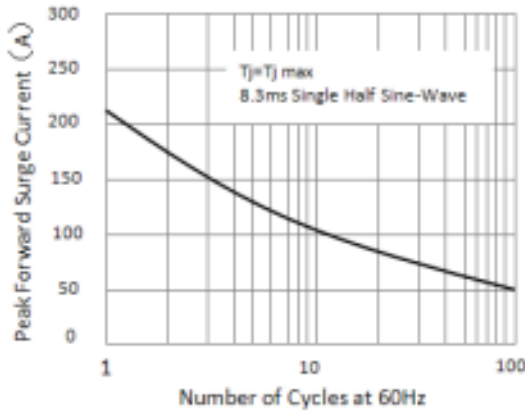

Figure 1. Maximum Non-Repetitive Peak Forward Surge Current

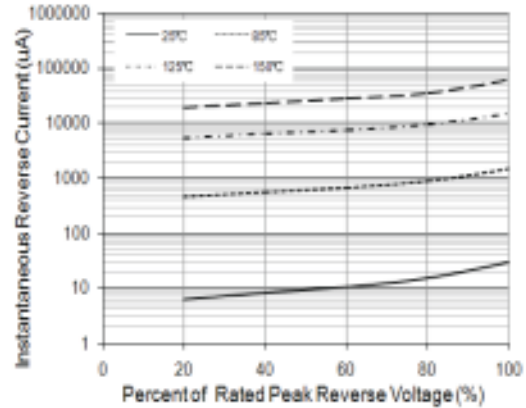

Figure 2. Typical Reverse Characteristics

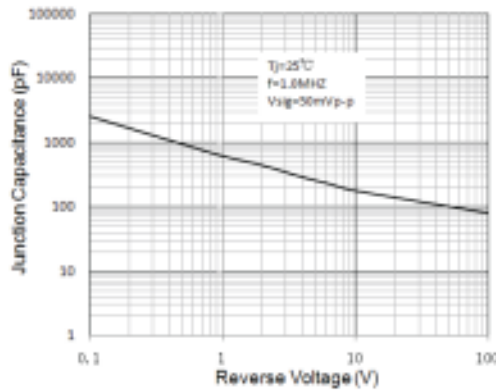

Figure 3. Typical Junction Capacitance

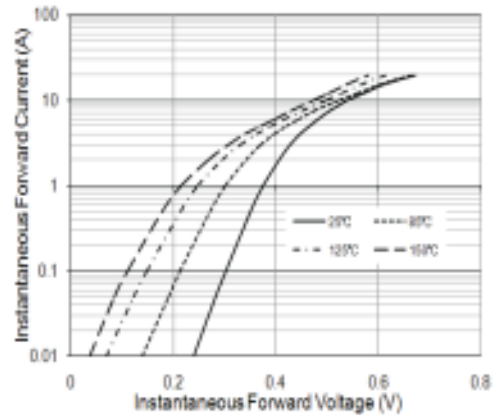

Figure 4. Typical Instantaneous Forward Characteristics

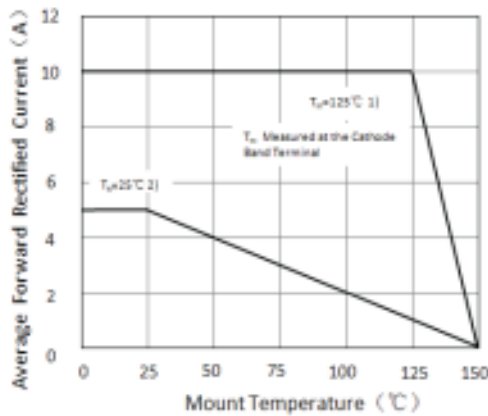

Figure 5. Forward Current Derating Curve

Notes

- 1) Mounted on P.C.B with 30*30mm copper pad area
- 2) Fre air, Mounted on recommended copper pad area FR4 PCB($R_{\theta JA}=76^{\circ}\text{C}/\text{W}$)

Package Outline Dimensions

in inches (millimeters)

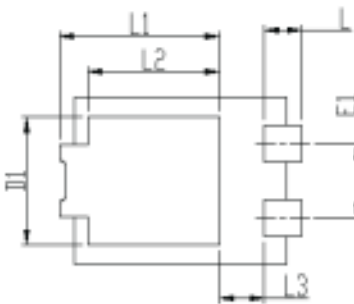
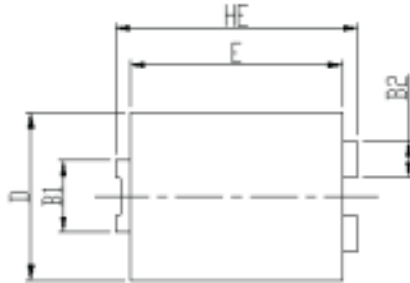

DIM	Unit: mm		Unit: inch	
	MIN	MAX	MIN	MAX
HE	6.4	6.6	0.252	0.260
E	5.6	5.8	0.220	0.228
D	4.1	4.3	0.161	0.169
B1	1.7	1.9	0.067	0.075
B2	0.8	1	0.031	0.039
A	1.05	1.2	0.041	0.047
C	0.3	0.4	0.012	0.016
L	0.85	1.1	0.033	0.043
L1	4.2	4.4	0.165	0.173
L2	3.52 Typ.		0.139 Typ.	
L3	1.1	1.4	0.043	0.055
D1	3	3.3	0.118	0.130
E1	1.86 Typ.		0.073 Typ.	

Soldering footprint

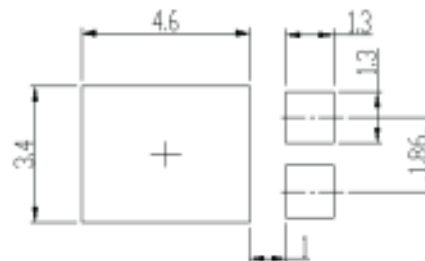

Packing Information

Packing quantities:

5000 pcs/Reel, 12mm Tape, 13" Reel

Tape & Reel Specification

